

Using a Kit to Set up a Cattle Scale System under a Squeeze Chute

Josh Jackson, Biosystems and Agricultural Engineering

On cattle operations, the use of a scale system to weigh animals is vital to the proper administration of health products such as dewormers and antibiotics, and for making management decisions. The cost associated with commercially available scale systems has traditionally limited producers' willingness to invest in this tool. The University of Kentucky Cooperative Extension publication *Constructing a Platform Alley Scale* (AEN-140) explains how to assemble a low-cost platform scale for use in an alley. Nonetheless, putting a scale in an alley is not a desirable option for many producers. Integrating a scale system into an existing chute could be a more cost effective and desirable location for weighing livestock. A scale system mounted to a chute allows animals to be securely restrained for weighing and minimally impacts cattle flow through the working facilities. Excitable animals can be properly restrained and, with their movement limited, cattle can be weighed accurately.

References

Higgins, S., S. Mehlhope, L. Moser, and S. Wightman. 2017. *Appropriate All Weather Surfaces for Livestock* (AEN-115). University of Kentucky Cooperative Extension Service. <http://www2.ca.uky.edu/agcomm/pubs/aen/aen115/aen115.pdf>.

Jackson, J. 2019. *Constructing a Platform Alley Scale System* (AEN-140). University of Kentucky Cooperative Extension Service. <http://www2.ca.uky.edu/agcomm/pubs/AEN/AEN140/AEN140.pdf>.

Building a Scale System

Three main materials are required for the construction of a chute scale:

1. Livestock scale kit (search ecommerce sites for "livestock scale kit")—the kit used in this publication included:
 - Four 5,000 lb load cells (20,000 lb total capacity)
 - Four mounting blocks
 - Four spacers
 - Display (readout for weights)
 - 110-volt connection
 - Battery power
 - Associated fasteners
2. Steel channel (commonly referred to as 5-inch C-channel steel) C5 x 6.7 (in x lb/ft)
3. Conduit, ¾-inch diameter
 - Spacer blocks for conduit (if needed/used)

Be sure to wear the appropriate personal protective equipment such as safety glasses, ear plugs, gloves, etc., for this project.

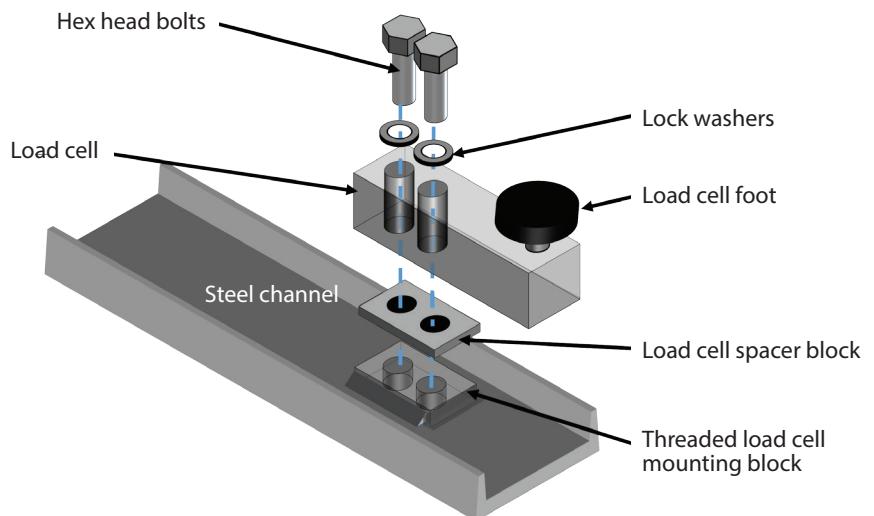

For an overview of the process, be sure to watch the video *Setting up a Cattle Scale System from a Kit* on YouTube channel Josh Jackson.



Project Layout (General Description)

1. For this project, the C-channel will be attached to the bottom of the existing chute, and the load cells will be attached the bottom of the C-channel.

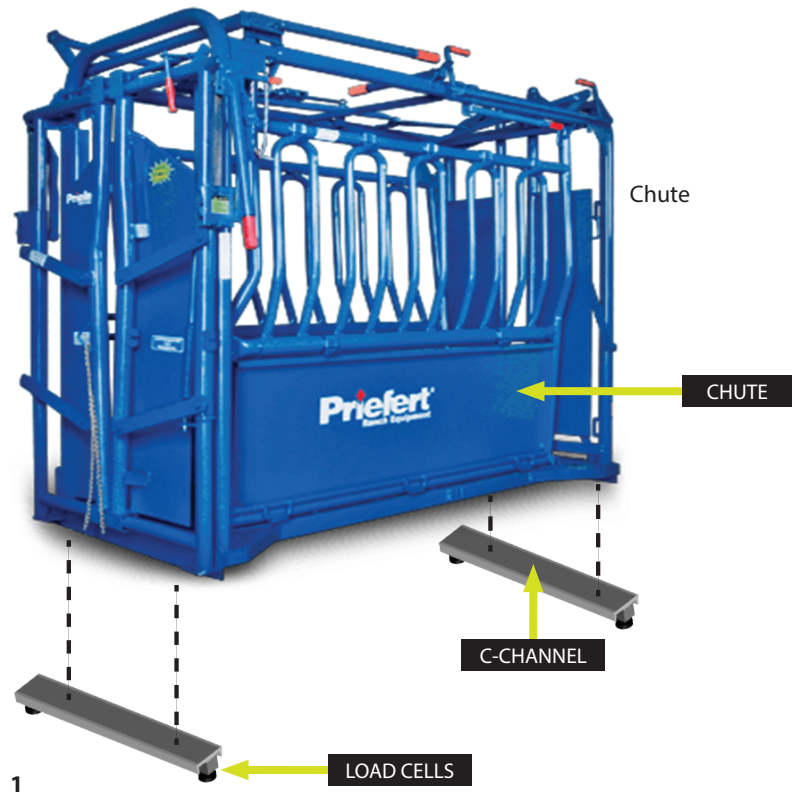

Important Considerations Prior to Building

2. Prior to installing the C-channel and load cells under the squeeze chute, consider that cattle may be required to take a higher step into the chute. This additional height may impair the movement of the cattle through the chute. This can be a real issue for the flow of cattle.



3. To solve this potential issue, one might consider digging down 2 to 3 inches (or more) before pouring the pad to minimize this step up. The area for the chute and load cells could be made lower than the rest of the alley to compensate for this additional height.

Remember to consider space requirements for a palpation cage if installed. Alternatively, a step or ramp could be added in the area leading up to the chute.

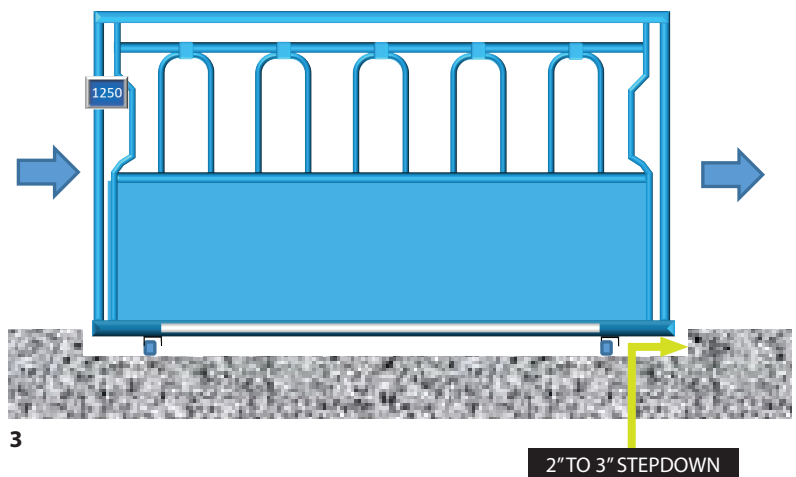

Make a Plan for Wiring

4. Take time to evaluate the chute system's layout and think how to run the load cell wires (approximately 20 ft of cord per load cell and 15 ft for the display) and where to attach the junction box and display.

Make sure the moving mechanisms (doors, kickouts, squeeze, tail gate, or panels) are not inhibited by the location of the display, junction box, conduit, wires, or steel channel.

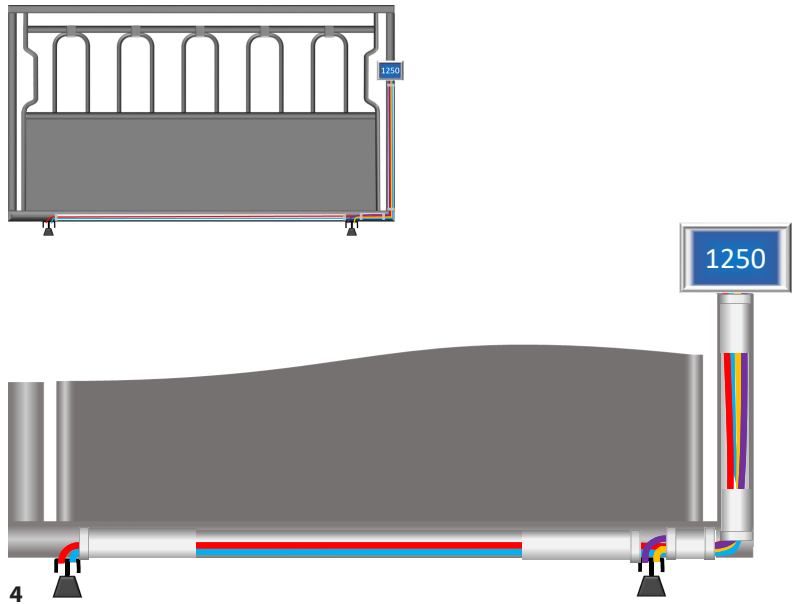

5. If the chute is going to remain in the same location for the remainder of its service life, the junction box and display can be located adjacent to the chute. Conduit can be attached to the concrete floor to ensure that all the wires are protected. Protecting the wires will ensure the longevity of the system. Another option for older chutes that are going to remain stationary is to look for places to attach the junction box to the bottom side of the chute.



6. For a chute that must remain portable, make sure the planned location of the steel channel and wires will not interfere with its mobility (wishbone carriage or other features). Several producers move their chute between farms using pallet forks and flatbed trucks. These producers lift the chute from the bottom. If that will be the case, make sure wires and junction box are clear of the pallet forks. The junction box and display could be attached to the back left end of the chute. Conduit could be used on the left side of the chute to protect and transfer the wires to the back of the chute. The left side is typically selected for the conduit, as the chute "kick out" or "emergency exit" opens to the right side on most chutes. Some chutes open on both sides so additional considerations would have to be considered. Just be sure to

*MAKE A PLAN FOR WIRING. DO NOT CUT ANY WIRES.
This example shows excess wire tied to vertical conduit.*

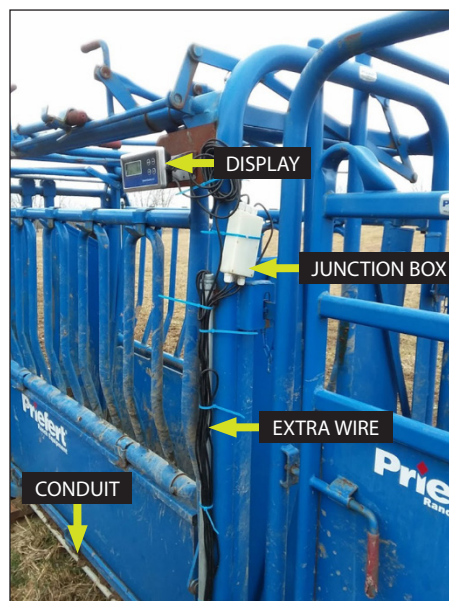

6

Step 1: Create a Level Surface

7. To ensure the accurate reading of the constructed scale system, the scale must sit on a firm and level surface. The general recommendation is to use a concrete pad with a minimum thickness of 4 inches. No rebar should be required if poured and cured properly at the optimum moisture and temperature. Follow the manufacturer's instructions on the cement bag for the required amount of water to add to the mixture. The temperature during pouring and curing should be approximately 50 to 60°F. A base and subbase material of gravel under the concrete is essential. Consider installing thicker (6 inches) concrete if heavy equipment is going to be run across the concrete pad. See UK CES publication *All Weather Surfaces for Livestock* (AEN-115).



7

Step 2: Cut Metal to Length

8. Depending upon type and width of the chute, cut the steel channel to match the footprint width of the widest part of the chute bottom. Make sure the channel does not interfere with any moving parts of the chute (head gate, side exit gate, tail gate, squeeze mechanism, etc.). For the example in this publication, two 40-inch C5 x 6.7 (in x lb/ft) steel channels (5-inch C-channel) are required for the front and back of the chute. The total length of the steel channel should be between 24 and 40 inches. If the steel channel is too short, it could pose a tipping hazard. However, if the steel channel is too long, then it becomes a tripping hazard.

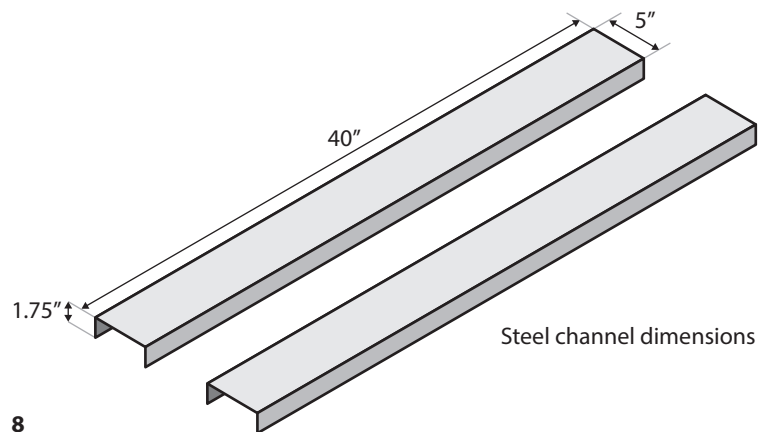

8

9. Cut the metal using a band saw, grinder with cutting disc, or chop saw. If you prefer, check with local steel suppliers who may also be able to cut the channel to length.



9

Step 3: Weld Mounting Block and Conduit to Steel Channel

10. The kit should contain four threaded mounting blocks. Weld mounting block 4 inches from each end of the 40-inch steel channel.

Do NOT weld on or around the actual load cells as this will destroy them!

11. For systems moved with a pallet fork, drill a $\frac{5}{8}$ -inch hole on one end of each channel to allow wire to be passed through.

12. Make sure to use a grommet to protect the wires.

13. Conduit can be welded to the bottom of the steel channel to protect the wires.



10

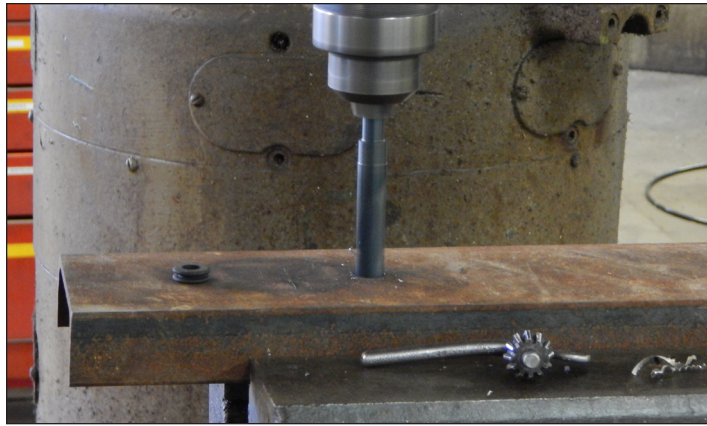

11



12



13

Step 4: Safely Weld Steel Channel to Bottom of Chute

14. Several different options exist for lifting the chute so that the steel channel can be welded to the chute. One way to lift the chute is to use the manufacturer's transportation system (i.e., wishbone carriage).

15. Another way would be to use pallet forks to lift the chute. To ensure the safety of the welder, the chute must be stabilized. Chains, ratchet straps, jack stands, blocks, or a combination of these items should be used to ensure that the chute will not tip or fall during welding.

16. Prepare the surface of the chute for welding by cleaning off mud and any other debris. Grind the paint off the area in which you are going to weld to ensure that you have good contact and current.

Again, Do NOT weld on or around actual load cells as this will destroy them!

17. In this example, the steel channel was placed near each end of the chute. Ensure that the location of the steel channel does not interfere with the opening of the head gate or tail gate. Ensure that the grommet is on the left side of the chute. Weld the steel channel under the chute.

Again, Do NOT weld on or around actual load cells as this will destroy them!

18. If needed, attach metal blocks to provide an offset for conduit.

19. Weld conduit to chute system.



14

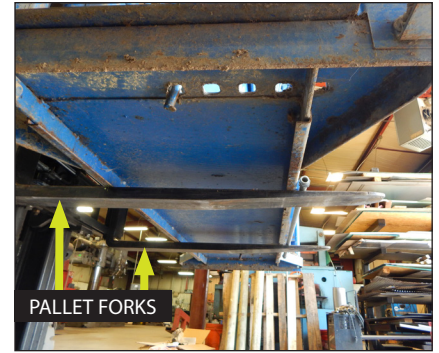

15



16



17

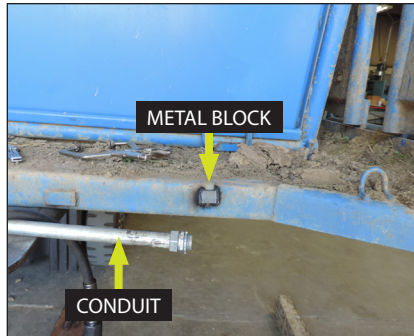

18

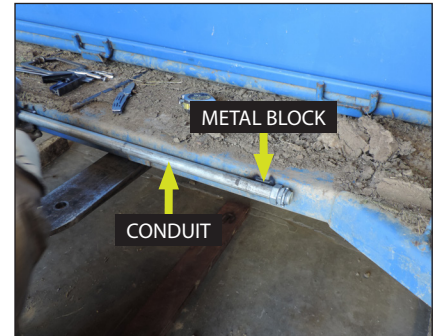

19

Step 5: Attach Load Cells and Spacer to Mounting Block

20. Attach load cells on the right side of the chute. A spacer block is included in the kit and is used to ensure that the load cell has enough space to deflect with the addition of loads. Ensure that the arrow is pointing away from the feet and toward the "load" of the chute.



20 (right side of the chute)

Step 6: Run Wires from Load Cells to Junction Box

21. Run wires from load cell on the right side through conduit to the left side.

22. Attach the feet and pull wires through the grommets on the left side of the chute.

23. Run wires from the front load cells into the conduit running along the left side of the chute (two wires going through conduit).

24. Run wires from the back-load cells through the grommet on the left side. Run all wires through conduit to the back end of the chute.

25. Pull wires through the vertical conduit pipe.



21 (left side of the chute)

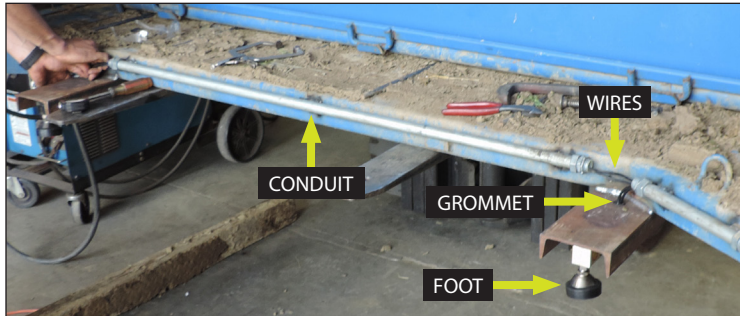

22

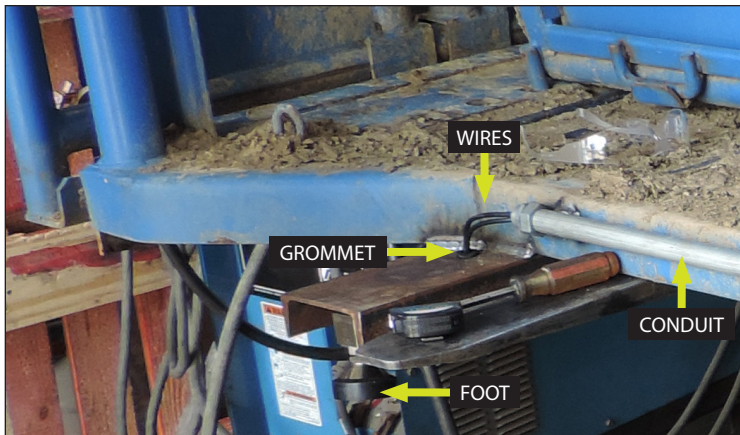

23

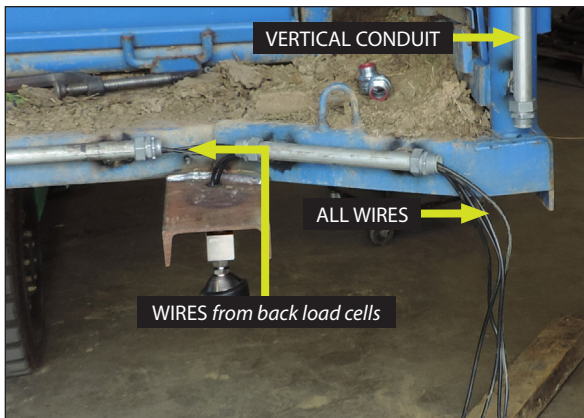

24 (left side of the chute)

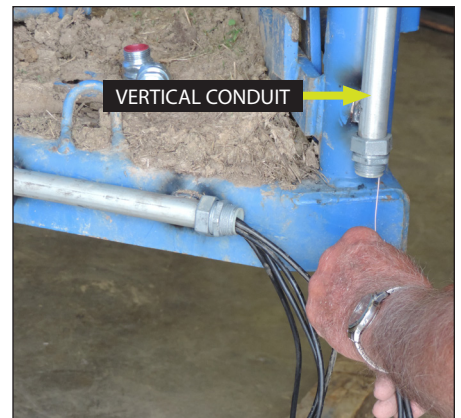

25

Step 7: Attach Junction Box and Display

26. Run wires into junction box. Follow the directions supplied with the load cell kit. Typically, five screw terminal blocks are in the junction box with one terminal block for each of the four load cells and one for display. Each terminal block will have connections for the five individual wires in the cable from each load cell to attach. The color-coded wires from each bundle should match the manufacturer's specifications. Do not cut any wires since this would change the calibration.

27. Wiring for this example was:

Went to:

- Exc Black wire
- Sig White wire
- SHLD Yellow wire
- +Sig Green wire
- +Exc Red wire

Numbers 1 through 4 represent the screw blocks for individual load cells. A separate screw terminal block is for the display.

Follow the wiring instruction provided by the manufacturer as this layout may have changed.

28. Alternatively, if the chute is to remain stationary at one location: Attach the junction box to the underside of the chute. Zip ties are a quick and easy means of attaching the junction box. Zip ties can also be used to capture some of the extra wire from the load cells to ensure that it is not a tripping hazard.

29. Close up of junction box underneath a chute.

30. If the chute is going to be moved frequently, attach a mounting bracket for the display to back end of the chute.

31. Protecting the scale system wires and cables from unnecessary damage is key to the longevity of the system. Use zip ties to neatly hold extra wires and secure junction box to chute.



26

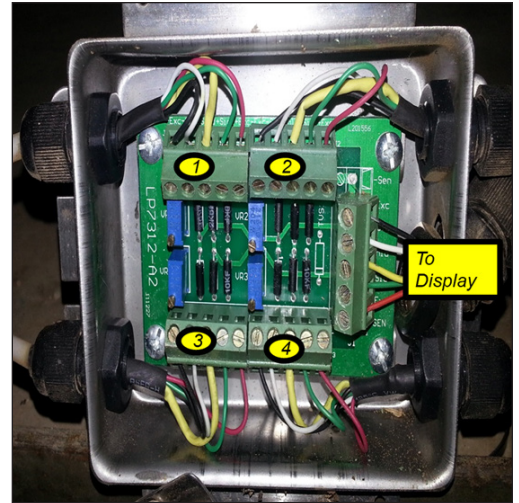

27



28



29



30



31

Step 8: Calibrate

32. This scale system must be calibrated by the producer and uses a two-point calibration (first, at zero—where no weight has been added to the scale, and then with a known weight added to the scale). Calibrate with a least 1,000 to 1,200 lb of known weight, as this would be representative of the animals measured. The known calibration weight could be mineral bags, feed bags, tractor weights, a known volume of water, or anything else where the weight is known. Follow the manufacturer’s instructions for calibrating scales. Calibration is a vital step as the system can only be as accurate as programmed. Validate during operation with other known weights.

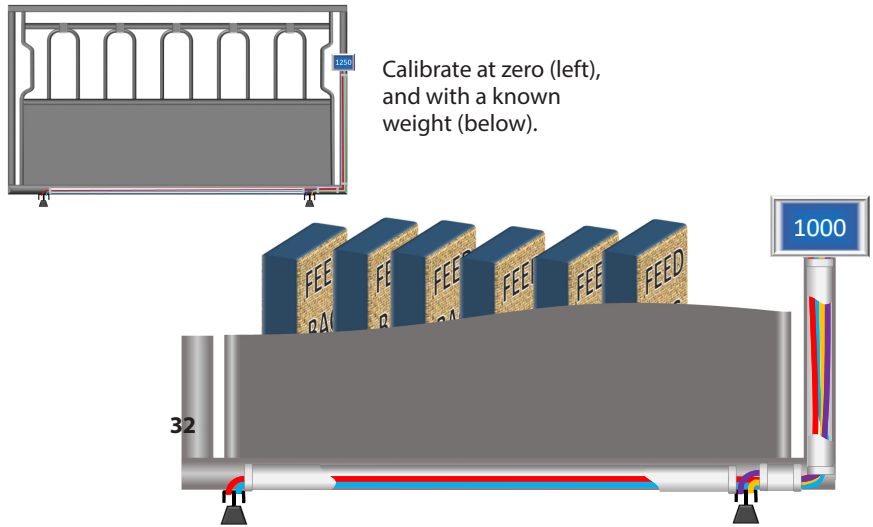

Other Considerations

33. With only four points of contact with the ground (each load cell), the chute will be more prone to gradual forward movement (“scooting”) from cattle entering quickly and caught by the head gate. A “bump” plate could be used to prevent the movement of the chute and scale system. Wear-resistant plastic would allow for impact to the recorded weight to be minimized. Avoid chaining to posts as this will influence the weight characteristics.

34. For stationary chutes, conduit can be attached to the concrete and used to protect the wires going to the display.

35. Keep in mind that the scale system constructed is not an official scale for the buying and selling of livestock. The scale should be used for making on-farm data-driven decisions for management purposes.



33



34



35

Mention or display of a trademark, proprietary product, or firm in text or figures does not constitute an endorsement and does not imply approval to the exclusion of other suitable products or firms.

Cooperative Extension Service

Agriculture and Natural Resources
Family and Consumer Sciences
4-H Youth Development
Community and Economic Development

MARTIN-GATTON COLLEGE OF AGRICULTURE, FOOD AND ENVIRONMENT

Educational programs of Kentucky Cooperative Extension serve all people regardless of economic or social status and will not discriminate on the basis of race, color, ethnic origin, national origin, creed, religion, political belief, sex, sexual orientation, gender identity, gender expression, pregnancy, marital status, genetic information, age, veteran status, physical or mental disability or reprisal or retaliation for prior civil rights activity. Reasonable accommodation of disability may be available with prior notice. Program information may be made available in languages other than English. University of Kentucky, Kentucky State University, U.S. Department of Agriculture, and Kentucky Counties, Cooperating.

Lexington, KY 40506 Revised 04-2024



Disabilities accommodated with prior notification.